



HYDROSTATIC DRIVE SYSTEM FOR DECANTER CENTRIFUGES

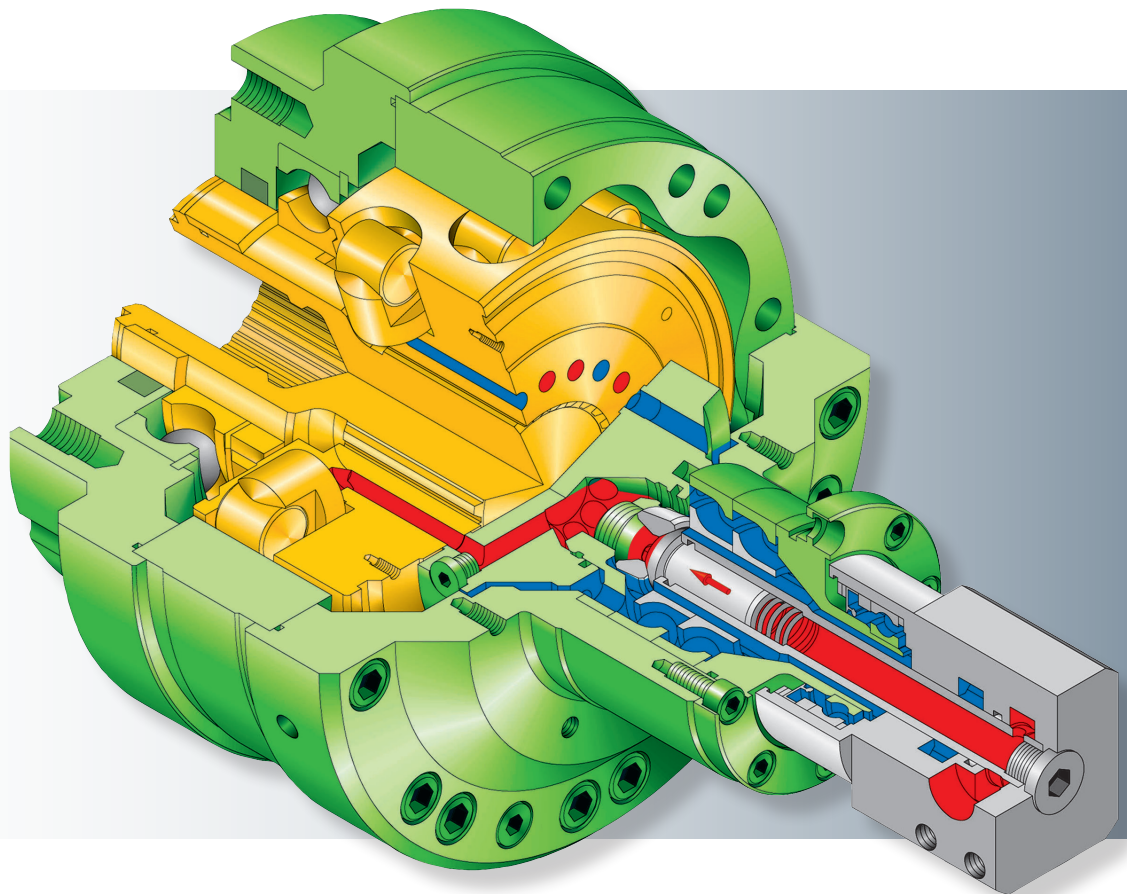



Table of Contents

Hydrostatic Drive System.....	3
1 Hydraulic Motor ROTODIFF® and Hydraulic Unit.....	3
1.1 Working Principle of a Solid Bowl Centrifuge with Hydrostatic Drive System.....	4
1.2 Setup of Hydraulic Drive Systems	5
2 ROTODIFF®	6
2.1 Working Principle of the Hydrostatic Scroll Drive Motor	6
3 Pump Unit for Scroll Drive	9
3.1 Control and Regulation Part	10
3.2 Electronic Regulation Systems	11
3.3 Hydraulic Regulation System.....	14
4 Pump Unit for Bowl and Scroll drive	15
4.1 Control and Regulation Part	15
4.2 Full Hydraulic Unit E-B/C	16
4.3 Full Hydraulic Unit E-B	17
5 Benefits of Hydrostatic Drive Systems	18
5.1 Quality and Reliability	18
5.2 Excellent Weight/Torque Ratio.....	18
5.3 Overload Protection	18
5.4 Behavior of the Drives During Particular Operations	19
5.5 Automatic Operation and Regulation.....	19
5.6 Highest Energy Efficiency and Increased Through-Put Capacity	19
5.7 Reduction or Elimination of „Chatter or Slip-Stick”.....	20
5.8 Explosion Proof (ATEX) – ATEX Certification-ZONE 1	20
Products.....	21
ROTODIFF®	22
ROTODIFF®	23
ROTODIFF®	24
Pump Unit for Scroll Drive	25
Pump Unit C.....	26
Pump Unit B/C	27
Pump Unit VFD.....	28
Full Hydraulic Unit for Scroll and Bowl Drive.....	29
Full Hydraulic Units E-B/C, E-C and E-B.....	30
Electronic Units	31
Electronic Units.....	32



Hydrostatic Drive System

1 Hydraulic Motor ROTODIFF® and Hydraulic Unit

A decanter centrifuge requires two independent drive systems. The bowl operates at a high rotational speed to create a high g-force. The scroll rotates inside the bowl with low speed to the bowl (differential speed).

The scroll and bowl drive of the hydrostatic drive system operate independently from one another in terms of energy and control technology. Torque and differential speed can be controlled according to load and pressure relation. The drives can be directly and infinitely variably controlled, which allows ongoing adaptation to the separating tasks.

The pump unit supplies the oil to the hydraulic motor ROTODIFF which is directly attached to the bowl. The rotor drives the scroll independently from the bowl. The scroll drive system consists of the hydraulic motor ROTODIFF and a hydraulic pump unit as well as a control unit. The bowl drive, on a semi hydraulic drive system, is controlled with a frequency-controlled electric motor which is provided by the centrifuge manufacturer.

The pump unit can also be expanded so that the bowl can be driven with a hydraulic motor. (full hydraulic drive).

VISCOTHERM develops and produces hydraulic drive systems for all kinds of applications. The drive systems are configured on the basis of the required torque (ROTODIFF) as well as the required differential rotational speed.





1.1 Working Principle of a Solid Bowl Centrifuge with Hydrostatic Drive System

The hydraulic oil pressure is directly proportional to the torque of the ROTODIFF scroll drive motor. This in turn is directly proportional to the quantity of the solid material deposited in the bowl.

This relationship makes it possible to achieve a closed control loop that enables the scroll differential rotation speed to be controlled depending on the deposited solid material.

As a result, the scroll rotation speed is automatically increased in proportion to the increase in scroll torque. The solid relationships in the bowl thus remain constant. That results in a constant maximum solid matter dryness with maximum output capacity. As a result, the centrifuge capacity can be optimally utilized, without blocking.

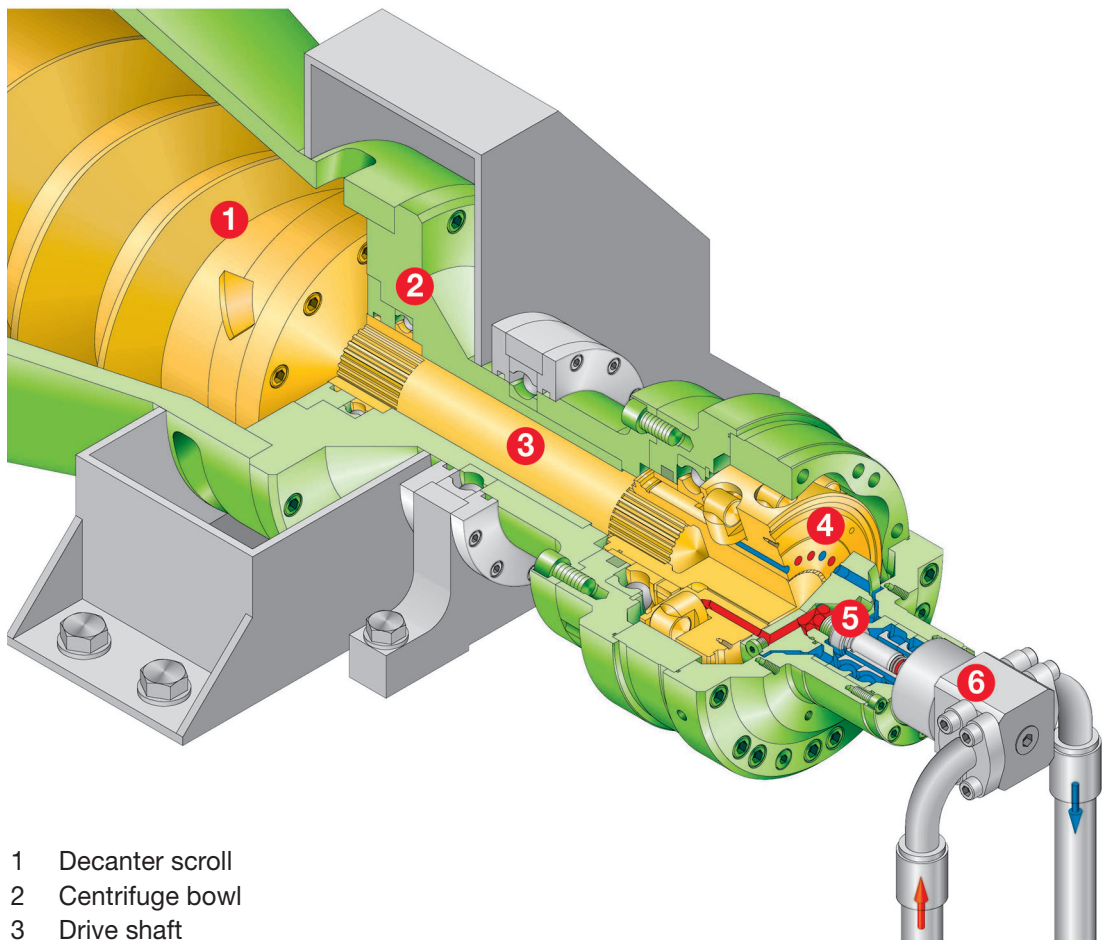

- 1 Decanter scroll
- 2 Centrifuge bowl
- 3 Drive shaft
- 4 Rotor
- 5 Transfer seal
- 6 Connection block (stationary part)



1.2 Setup of Hydraulic Drive Systems

1.2.1 Hydraulic Drive System for Scroll

The hydrostatic scroll drive system consists of the following components:

- 1 Pump unit (stationary)
- 2 Control System
- 3 ROTODIFF, hydrostatic scroll drive motor, mounted on the centrifuge bowl (rotating)

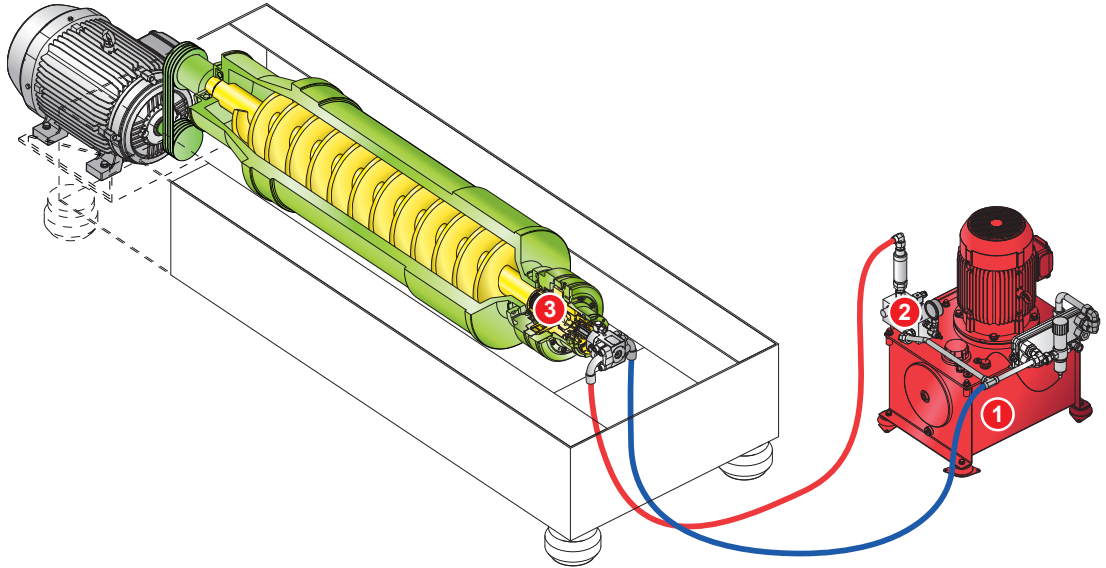

1.2.2 Hydraulic Drive System for Bowl and Scroll

The full hydraulic drive system consists of the following components:

- 1 Pump unit (stationary)
- 2 Control System
- 3 ROTODIFF, hydrostatic scroll drive motor, mounted on the centrifuge bowl (rotating)
- 4 Bowl drive

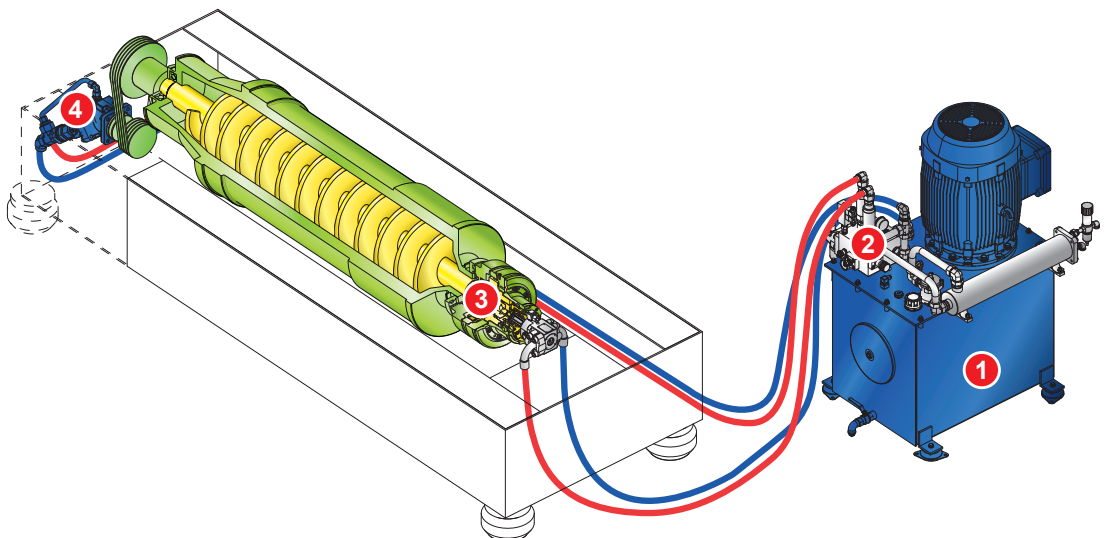



2 ROTODIFF®

2.1 Working Principle of the Hydrostatic Scroll Drive Motor

The hydraulic motor ROTODIFF is a slow speed, high-torque radial piston motor, whose housing (green) is bolted to the bowl. The ROTODIFF rotor (yellow) is connected with the scroll by a splined shaft, and this second speed is consequently the scroll speed. A highly efficient hydrostatic transfer seal is also integrated in the ROTODIFF.

With electronically controlled operating and control systems from Viscotherm or PLC, important values such as the hydraulic pressure, bowl and differential speed can be monitored, displayed and set. The scroll drive can also be controlled remotely. Thanks to field bus technology, these control units can simply be integrated into other process control systems.

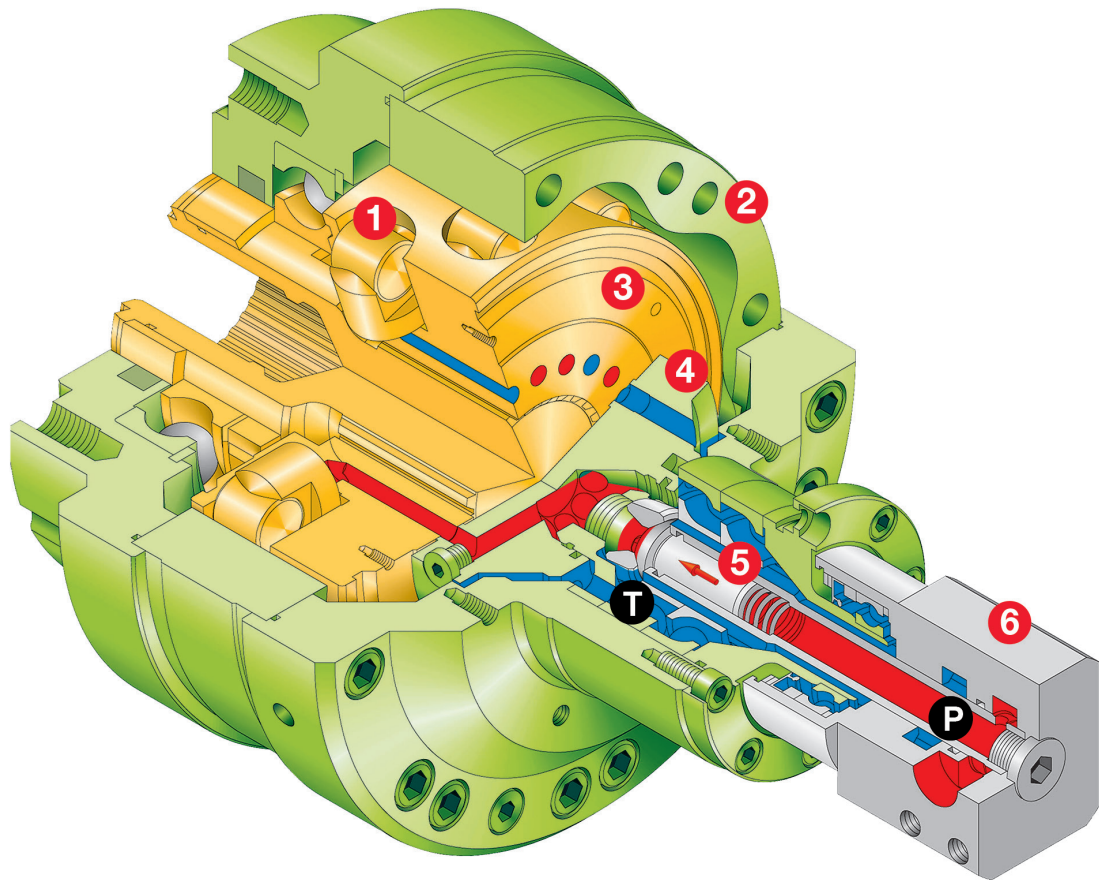

- 1 Roller piston
- 2 Cam
- 3 Rotor
- 4 Distributor
- 5 Transfer seal
- 6 Connection block (stationary part)

P High pressure / T Low pressure



HYDROSTATIC DRIVE SYSTEM FOR DECANTER CENTRIFUGES

The hydraulic motor is a positive displacement radial piston motor. The stator/cam (2) transmits the force exerted by the piston rollers (7) through pressure from the pistons (1). The tangential component of this force produces the rotation of the rotor (3). The pistons in the cylinders are subject to fluid under pressure via the distributor (4) which is mechanically linked to the cam. The pistons are thus alternately connected to the high pressure of the hydraulic feed system (working stroke; P) and the low pressure of the casing (return stroke; T).

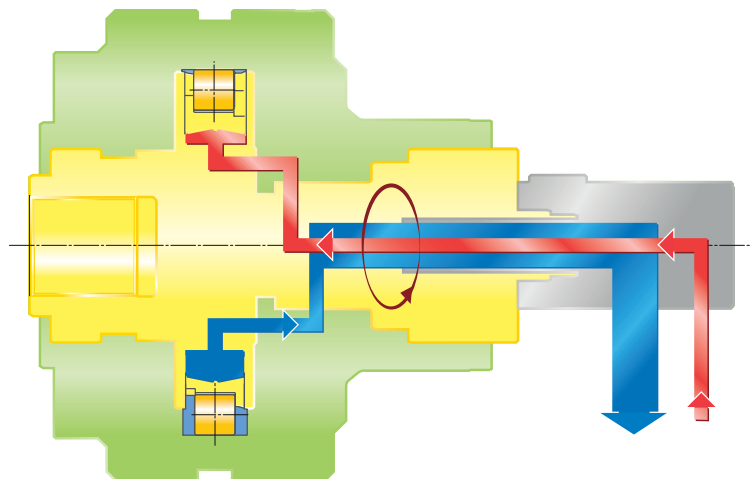
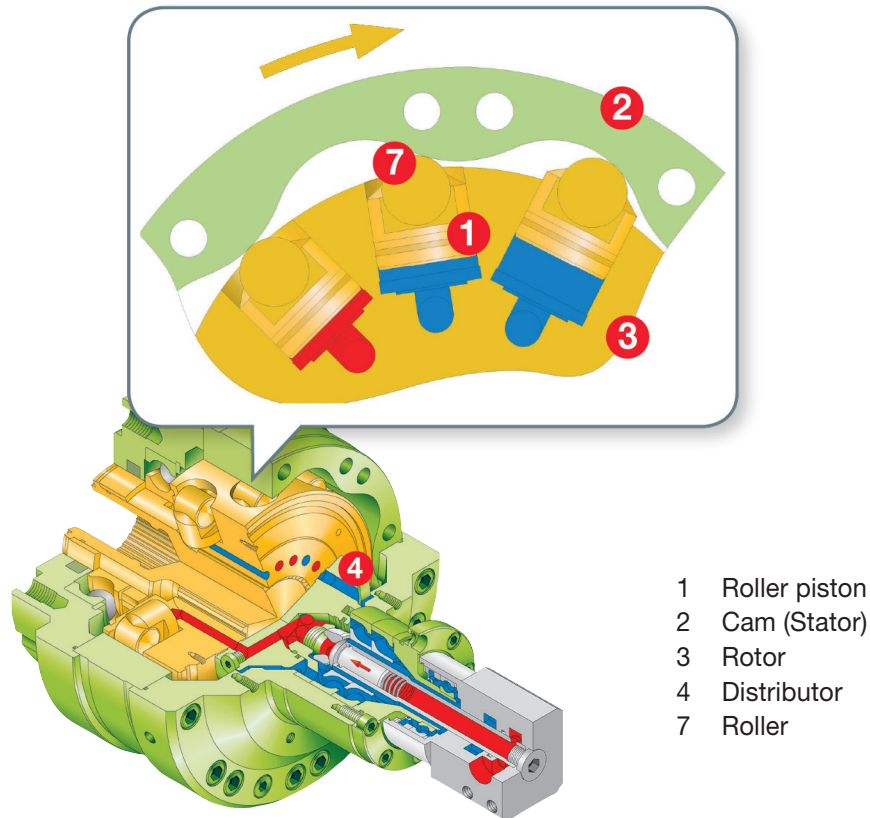



2.1.1 Working Principle of the Transfer Seal

The transfer seal is critical for the efficient function of the hydraulic motor:

- Very low leakage under highest pressures
- adequate passage for the high pressure oil flow
- extremely low friction loss

A ball cone (10) is placed on the rotating part eccentrically, and is connected via a double cone floating eccentric ring (9) to the stationary, compensation cap (8). The rotating ball cone and stationary compensation cap (parts 10 + 8) cause a tumbling motion of the floating eccentric ring, which continually laps and polishes the contacting surfaces. A considerable axial force is generated between the stationary and the rotating part. This axial force is contained by the two angular ball bearings (11).

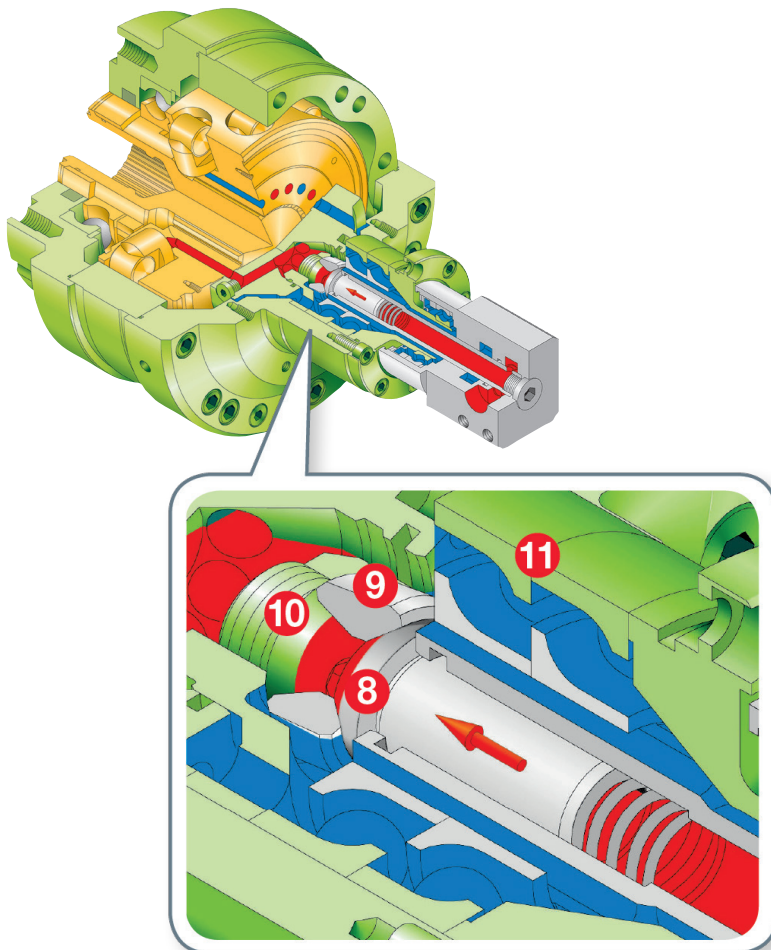

- 8 Compensation cap
- 9 Eccentric ring
- 10 Eccentric spheric-head
- 11 Angular ball bearing



3 Pump Unit for Scroll Drive

The pump unit uses an electric motor to drive a hydraulic pump, the flow from which controls the flow rate to the ROTODIFF (scroll drive) via a control block. The hydraulic operating pressure circuit that is dependent on the bowl drive contains all adjusting components and safety valves.

It is possible to select between three control systems depending on the requirement:

- **VFD-Control**
automatic, analogue control, electronic (frequency converter)
- **B/C-Control**
automatic, analogue control, electronic (proportional throttle valve)
- **C-Control**
automatic, analogue control, hydraulic

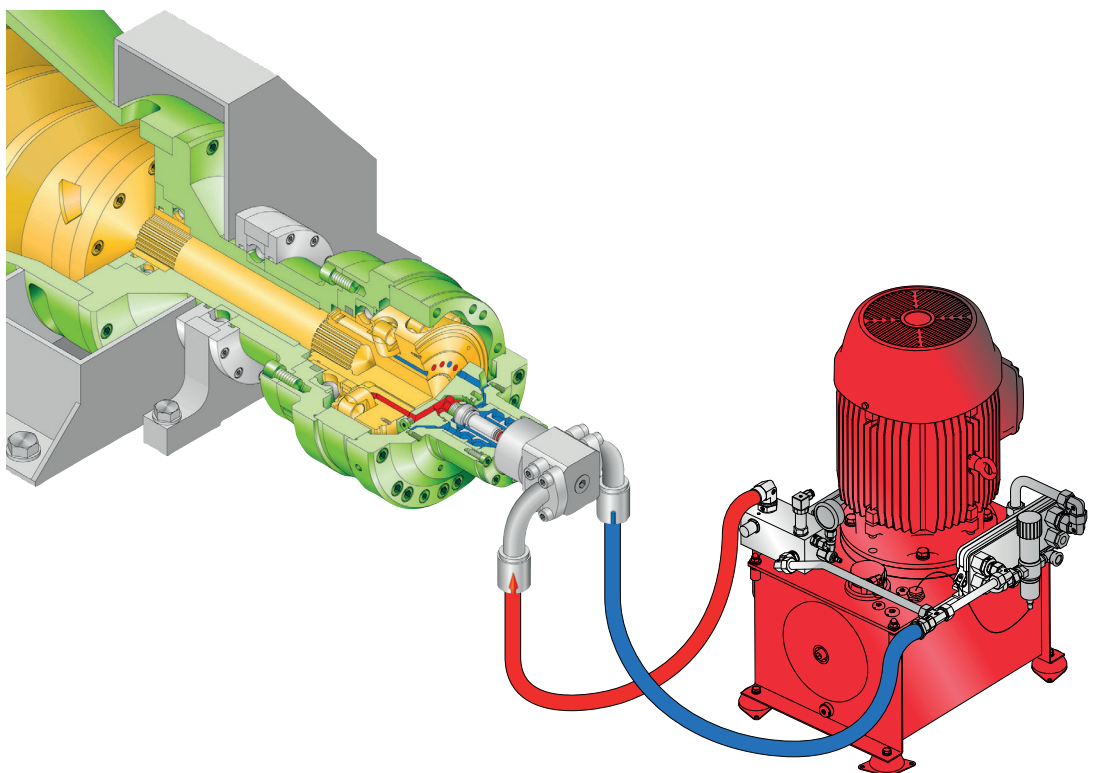



3.1 Control and Regulation Part

The hydraulic system pressure serves as a direct and accurate control variable. The hydraulic system pressure which is proportional to the scroll torque can be taken as a direct control signal and together with a suitable control system allows to achieve a very high degree of operational dependability and reliability of the drive.

There are two basic regulation models:

- The **digital regulation** permits a hand adjustable, fixed differential speed Δn , which will „boost” the differential speed to the maximum at some variable preset pressure (scroll torque)
- The **analog regulation** permits a setting of an adjustable differential speed (so-called base differential speed Δn), and a gradual increase in differential speed as pressure (scroll torque) increases. The point at which the differential speed starts increasing, called the regulation point P_1 , is variable, and the rate of increase is also adjustable.

With both analog and digital regulation, safety cut-outs are provided in the case of high torque P_2 and very high torque P_3 . These are signalled by pressure switches (adjustable) and are set-up to cut off the feed pump at P_2 and cut-off the bowl drive at P_3 .

A pressure relief valve protects the system from overload, preventing damage to the scroll drive by over-torque. This is at a higher value than P_3 , and has the effect of maintaining maximum torque on the scroll so that, as the bowl runs down in speed, the falling „G” force will allow the scroll to commence rotation again and „unplug” a blocked machine.

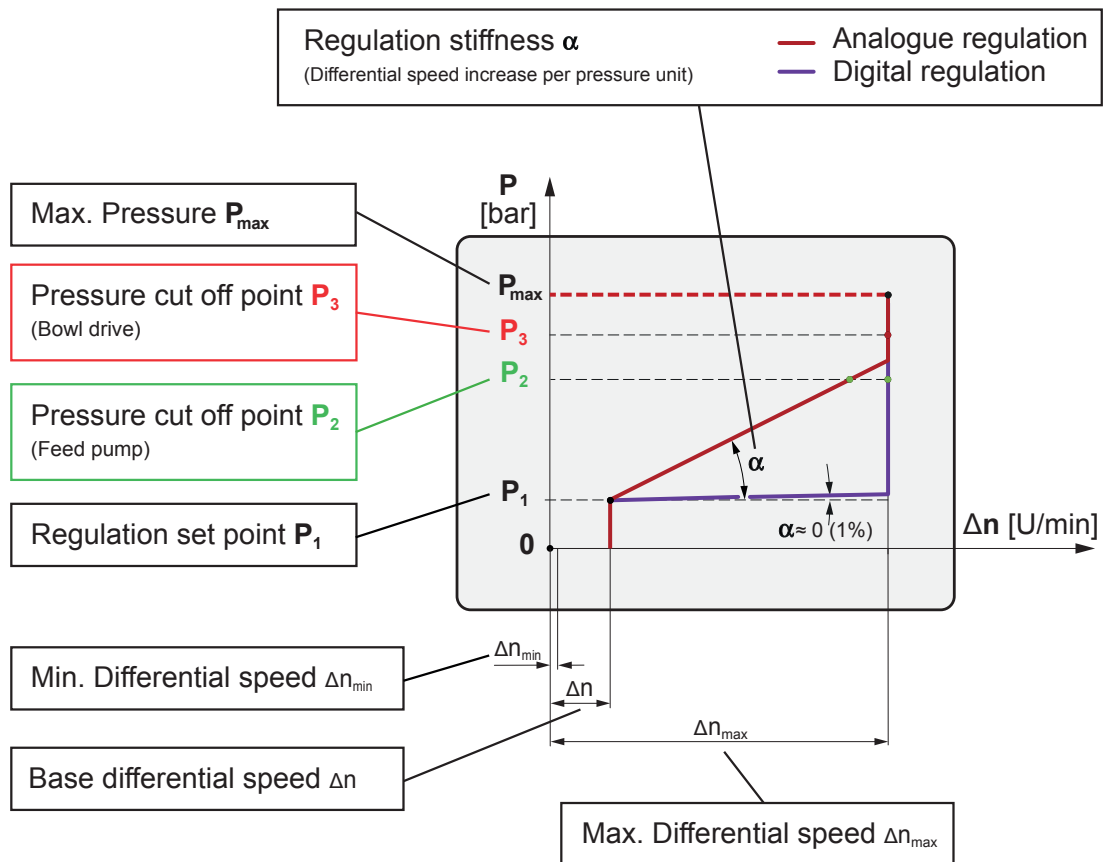



3.2 Electronic Regulation Systems

Depending on the type of electronic unit used, the following operation parameters can be displayed or displayed and controlled. It is also possible to process the measured operation parameters with an interface unit and control the transmitted data with a PLC controller. Therefore an easy integration through norm fieldbus interfaces into a larger process control system is possible.

Operation parameters:

- Hydraulic pressure in bar (with pressure sensor)
- Bowl speed in rpm (with speed sensor)
- Differential speed in rpm (with speed sensor)
- Additional measured values (oil temperature, vibration, ...)

The benefits of having an electronic control system are manifold:

- Precise control even in the lowest speed range
- Through feedback of the measured differential speed an operation within extremely low differential speed is possible (monitoring of the differential speed through a closed loop control circuit)
- Operating hours of the ROTODIFF, maintenance interval indicator- integration into larger electronic systems
- Utilization of additional regulation parameters is possible (vibration, feed rate, flocculation and so on)
- Integration capability into a superior system

There are two different electronic regulation systems available

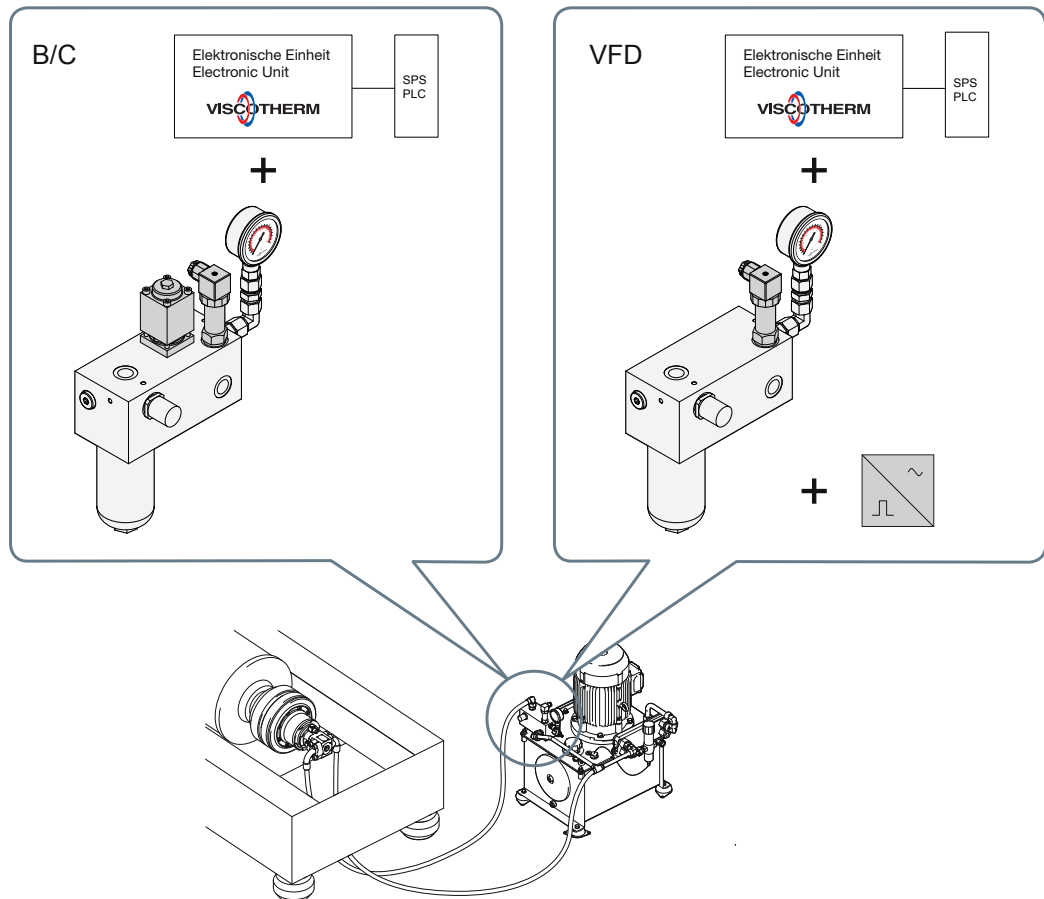



3.2.1 Pump Unit VFD

Mounted on the control block (VFD) is an electronic pressure sensor which transmits the measured system pressure (torque value) to the electronic display, control, or interface unit. The VFD Drive System consists of a pump unit with a constant displacement pump. The required variation of the oil flow and the resulting differential speed variation is achieved by changing the pumps rotational speed. This is done by a variation of electric motor speed with a frequency converter (VFD). Because the differential speed is proportional to the oil flow, an automatic regulation of the scroll speed is easily obtained.

The scroll torque is sensed hydraulically by the system pressure which is proportional to the scroll torque. Therefore the differential speed can be exactly monitored and automatically controlled with precise accuracy, analogue to the scroll torque and solids loading of the centrifuge. Alternatively the differential speed control signal can be directly taken from the power monitoring of the frequency converter.

Mounted on the ROTODIFF are bowl- and scroll speed sensors, the measured signals are also transmitted to the electronic unit. In addition, the oil temperature and oil levels are recorded at the pump unit.

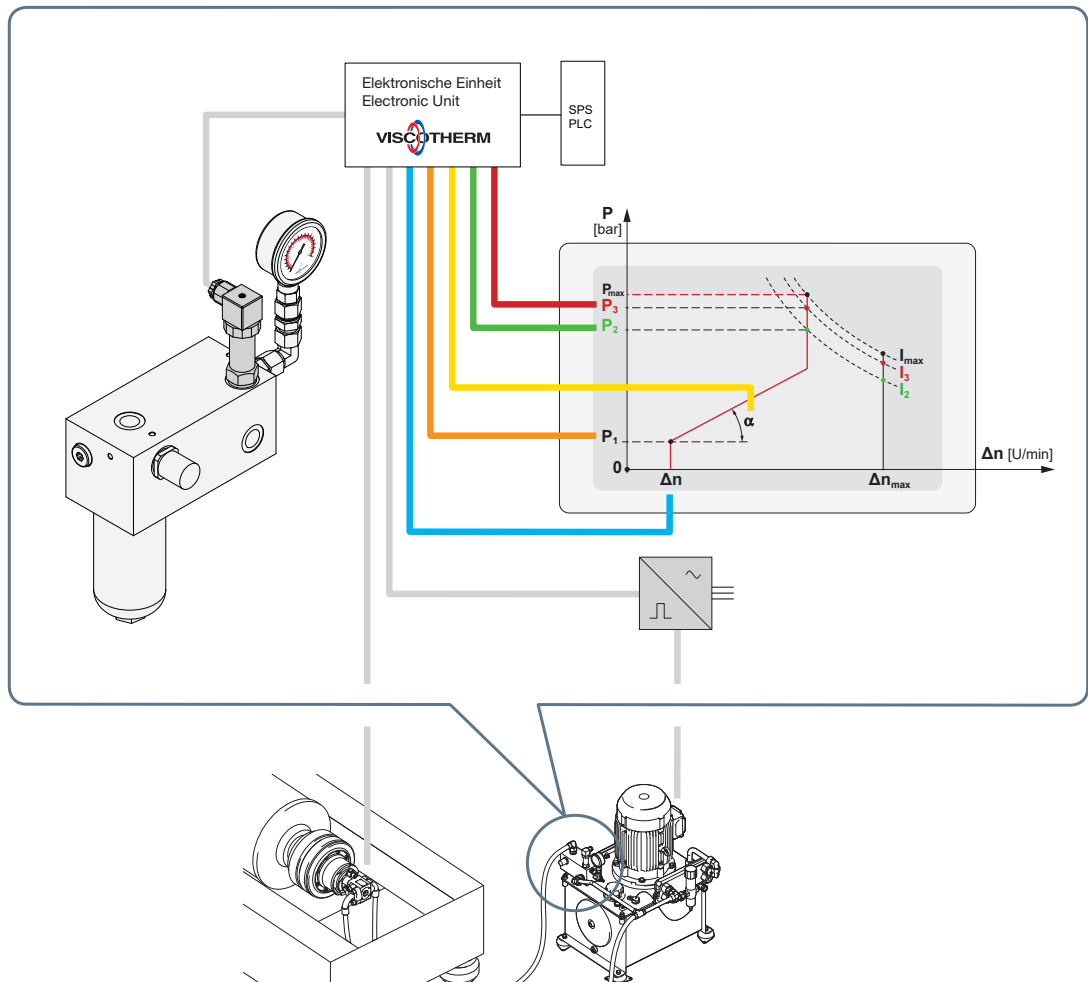

- | | | | |
|------------|--|-----------|----------------------------------|
| P_{MAX} | Pressure cut off point (pressure relief valve) | I_{max} | max. current |
| P_3 | Pressure cut off point bowl drive | I_3 | Current cut off point bowl drive |
| P_2 | Pressure cut off point feed pump | I_2 | Current cut off point feed pump |
| P_1 | Regulation set point | | |
| α | Regulation stiffness | | |
| Δn | Differential speed | | |



3.2.2 Pump Unit B/C

Mounted on the control block B/C is an electronic pressure sensor which transmits the measured system pressure (torque value) to the electronic display, control, or interface unit. A proportional valve mounted at the pump unit control block B/C controls the oil flow to the scroll drive ROTODIFF. The control current on the proportional throttle valve corresponds directly to the oil flow which is sent to the scroll drive motor.

Mounted on the ROTODIFF are bowl- and scroll speed sensors, the measured signals are also transmitted to the electronic unit. In addition, the oil temperature and oil levels are recorded at the pump unit.

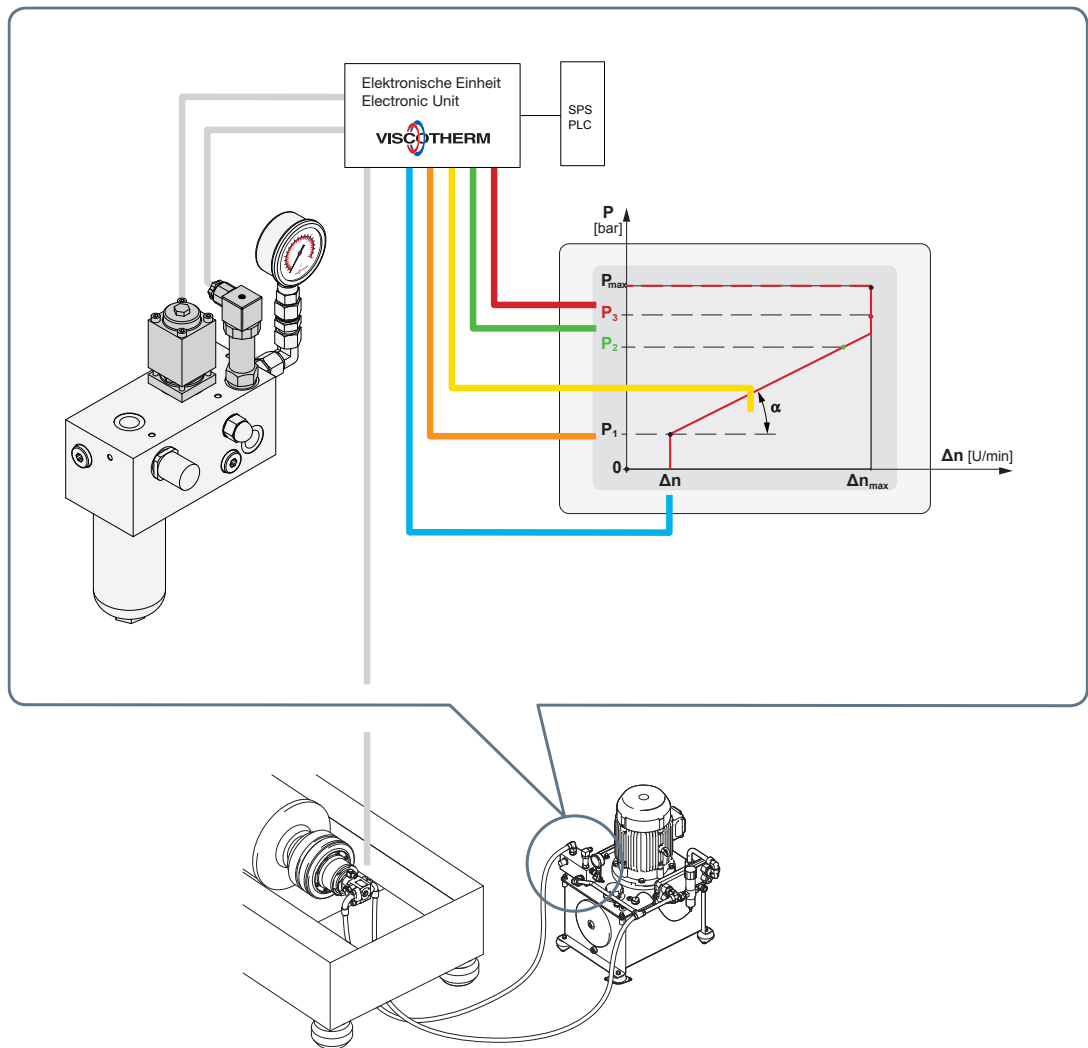

- | | | | |
|-----------|--|------------|----------------------|
| P_{MAX} | Pressure cut off point (pressure relief valve) | α | Regulation stiffness |
| P_3 | Pressure cut off point bowl drive | Δn | Differential speed |
| P_2 | Pressure cut off point feed pump | | |
| P_1 | Regulation set point | | |



3.3 Hydraulic Regulation System

3.3.1 Pump Unit C

The hydraulically regulated control block uses the direct feedback of the system pressure respectively scroll torque as a control variable. The automatic regulation characteristics are adjustable through three hydrostatic valves, the emergency functions P_2 and P_3 are set on a manometer pressure switch. In addition oil temperature and oil level are monitored on the pump unit. Such systems are advantageous for their easy operation and reliability.

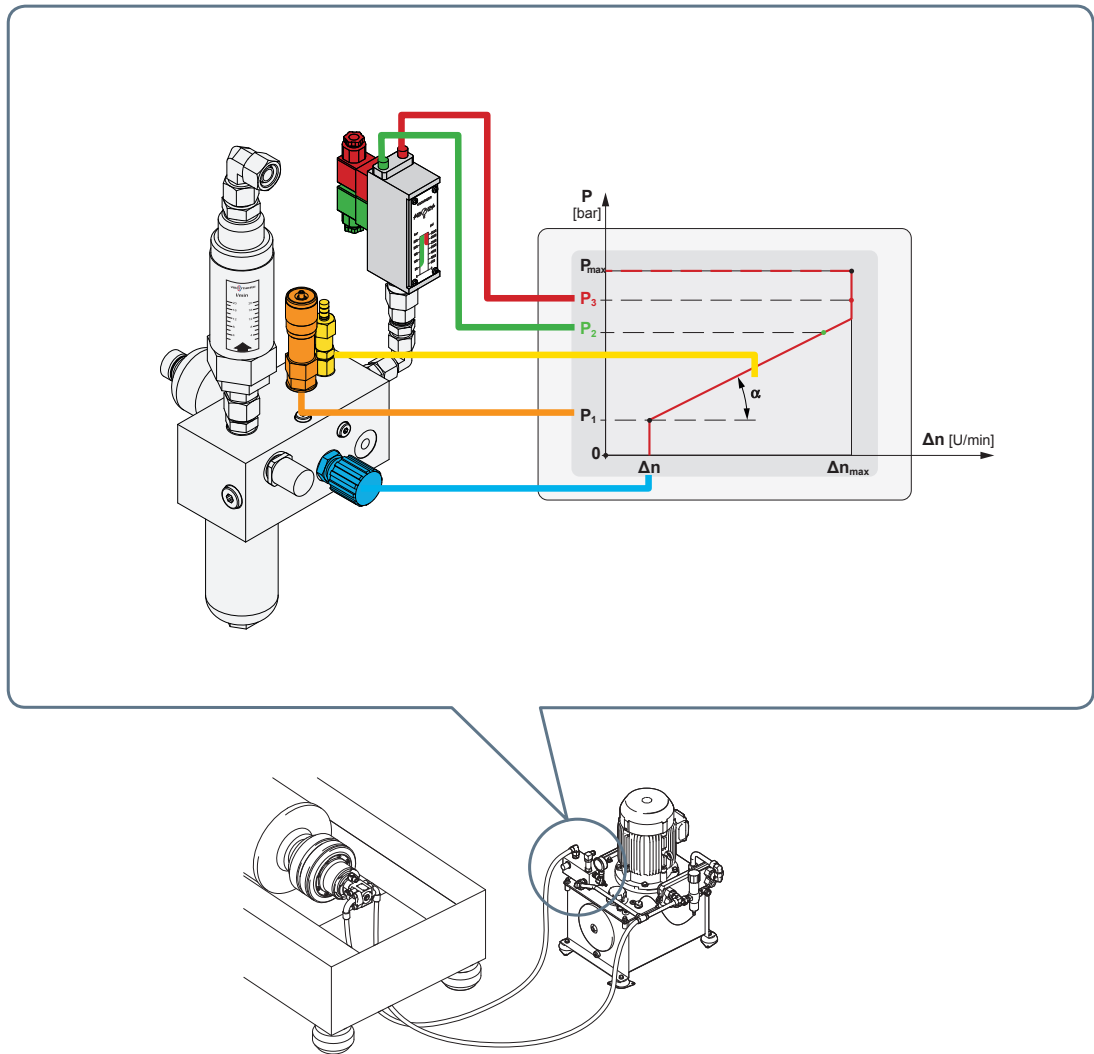

- P_{MAX} Pressure cut off point (pressure relief valve)
- P_3 Pressure cut off point bowl drive (red flag)
- P_2 Pressure cut off point feed pump (green flag)
- P_1 Regulation set point
- Δn Differential speed (throttle valve)
- α Regulation stiffness (regulation stiffness throttle)



4 Pump Unit for Bowl and Scroll drive

VISCOTHERM also develops and sales fully hydraulic pump units, so that both the scroll and the bowl are driven hydraulically. Infinitely variable control of the bowl and scroll rotation speed is possible using a fully hydraulic unit.

The pump units drive a hydraulic combination pump using an electric motor. Each working circuit has its own pump, the flow from which controls the flow rate to the ROTODIFF and to the bowl drive via a control block. The two independent hydraulic operating pressure circuits contain all adjusting components and safety valves.

It is possible to select between three control systems depending on the requirement:

- **E-B/C -Control**
automatic, analogue control, electronic with proportional throttle valve
- **E-C -Control**
automatic analogue control, hydraulic
- **E-B -Control**
automatic digital control, hydraulic

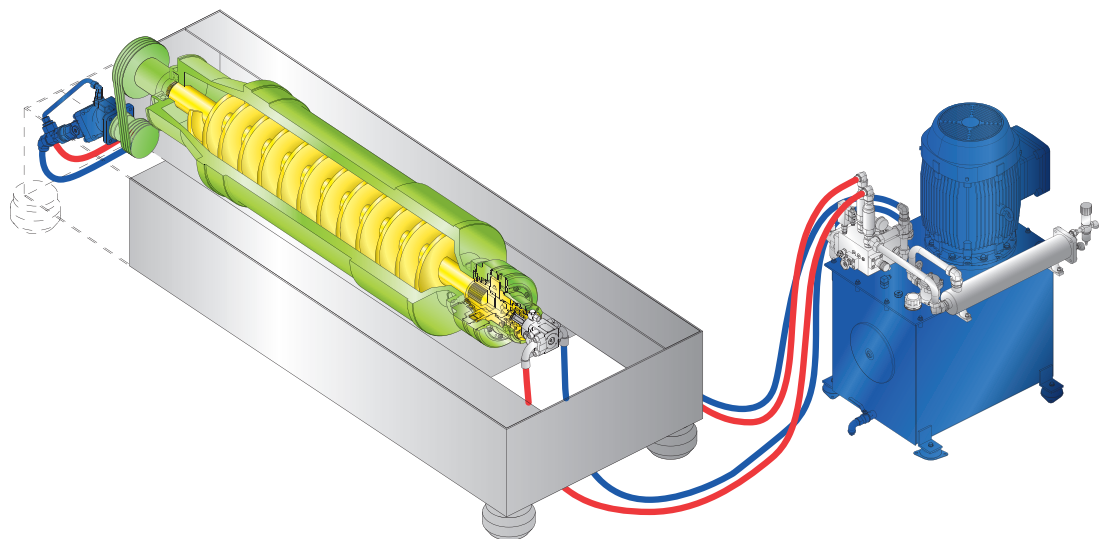

4.1 Control and Regulation Part

Full hydraulic pump units have two independent control circuits:

- The control and regulation part of the **scroll drive circuit** corresponds to that of the standard scroll drive, see chapter 3.1. There are also two different control mode models, digital or analog. Depending on the application the control is also available in an electronic or hydraulic version.
- The **control of the bowl drive circuit** is a variable speed control which can be executed electronically or hydraulically.



4.2 Full Hydraulic Unit E-B/C

Control Diagram

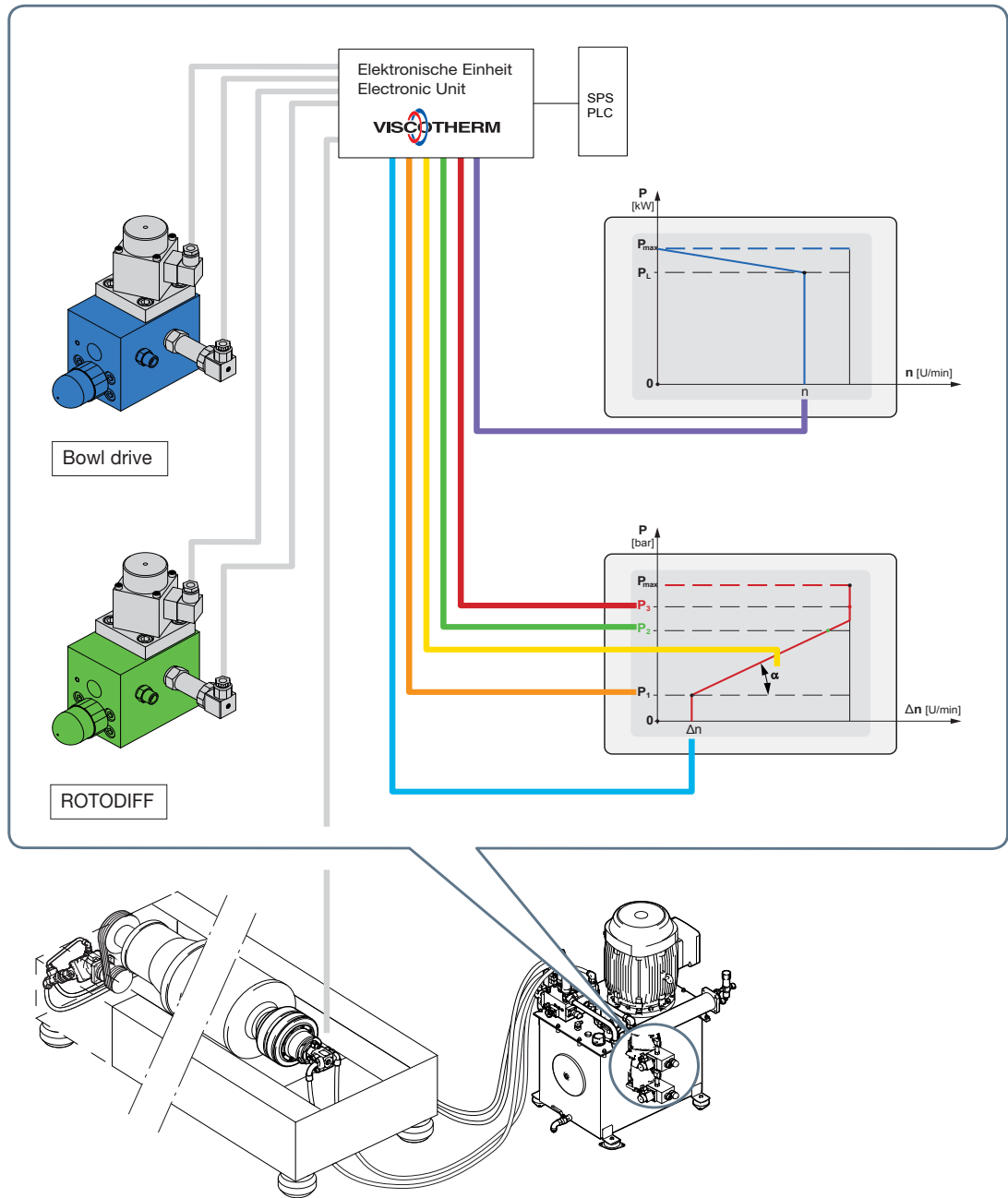

ROTODIFF

- P_{max}** Pressure cut off point (press relief valve)
- P₃** Pressure cut off point bowl drive
- P₂** Pressure cut off point feed pump
- P₁** Regulation set point
- Δn** Differential speed
- α** Regulation stiffness

Bowl Drive

- P_{max}** Pressure cut off point (press. relief valve)
- P_L** Limit control pressure
- n** Bowl speed



4.3 Full Hydraulic Unit E-B

Control Diagram

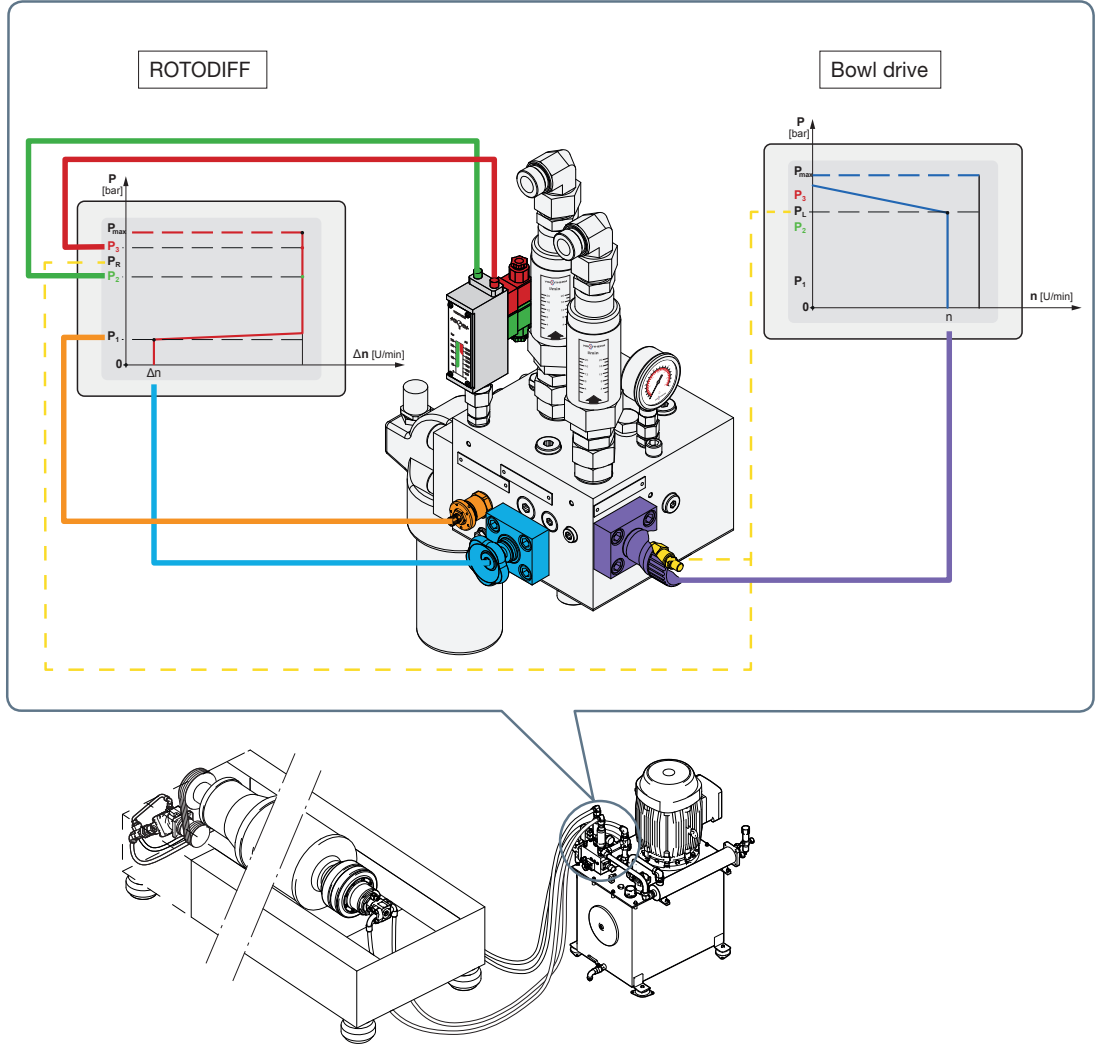

ROTODIFF

- P_{max}** Pressure cut off point (pressure relief valve)
- P₃** Pressure cut off point bowl drive (red flag)
- P₂** Pressure cut off point bowl drive (green flag)
- P₁** Regulation set point (pressure valve with scale)
- Δn** Differential speed (throttle valve with with handweel)

Bowl Drive

- P_{max}** Pressure cut off point (pressure relief valve)
- P_L** Limit control pressure (pressure cut off valve)
- n** Trommeldrehzahl (throttle valve with knob)



5 Benefits of Hydrostatic Drive Systems

5.1 Quality and Reliability

Decanter centrifuges are often placed in harsh environments, humidity, heat, dust, and so on. Under these operating conditions the hydrostatic drive system is particularly suitable because of the robust design and resilience.

Hydraulics are also used in industrial, military and transport applications where there is no room for error – the use differs widely from the most sterile to the dirtiest environments.

Examples include airplanes, railways, ships, submarines, elevators, construction equipment, mining, drilling and more.

- The hydrostatic drive system is especially suited to operate in such conditions because of the robust and simple construction; due to this it offers high operational safety
- Stable and reliable operation under fluctuating loading conditions this is one more reason the market place has justified the hydrostatic drive system
- Long Service life / Quality robust design and automatic heat dissipation
- No overheating of the hydraulic drive motor ROTODIFF, automatic continuous heat dissipation through the oil-conditioning system
- Hydraulic motors with only few slow moving parts are easy to maintain, in comparison to multiple stage gear-boxes with gears operating at higher speed
- Minimal operating and maintenance costs

5.2 Excellent Weight/Torque Ratio

The entire hydraulic drives made by Viscotherm (ROTODIFF product series) have an outstanding weight / torque ratio which is given due to the hydrostatic design.

- On average, hydrostatic drives have about half the weight of a standard gearbox with the same rated torque capacity
- This means that higher bowl speeds can be achieved
- Reduced overhung loading and a reduced moment of inertia considerably decrease the vibrations on the machine
- The excellent torque to weight ratio lead to an increased life time of the main bearings

5.3 Overload Protection

A torque overload or torque peaks do not cause any damage to a Viscotherm drive.

- All mechanical components are protected against overload by various safeguards and finally protected by a simple pressure relief valve



5.4 Behavior of the Drives During Particular Operations

The Viscotherm drive system is a closed kinematic drive chain, i.e. the conveyor drive is operated independently of the bowl drive system. Due to this fact, the conveyor drive system has full torque capacity in each operating mode:

- When the bowl is stationary (clean out of plugged scroll at stand still possible-change of direction of rotation possible).
- While the bowl is running up to speed
- During run-down of the centrifuge
- Ideal cleaning (CIP) at reduced bowl speed (lower G-Force)
- During power failure, the energy from the rotating bowl can be recovered and used for continued operation of the scroll speed and a controlled shut-down, it prevents plugging and costly maintenance

High differential speed and full torque capacity at the same time. The danger of plugging (and therefore a total disassembly of the centrifuge) is almost eliminated. Flushing is also assisted, since a high differential speed can be obtained at near-zero bowl speed.

5.5 Automatic Operation and Regulation

On gear-box drive systems complicated control measurements are necessary for the differential speed control. Bowl speed, pinion shaft speed, gear-box ratio and the electric motor current are factors for control errors.

The hydraulic system pressure serves as a direct and accurate control variable.

- The hydraulic system pressure which is proportional to the scroll torque can be taken as a direct control signal and together with a suitable control system allows to achieve a very high degree of operational dependability and reliability of the drive
- Control and monitoring of the operation with easy integration into a process controller through standardized fieldbus interface

5.6 Highest Energy Efficiency and Increased Through-Put Capacity

The hydraulic technology operates independently of the main drive.

- The scroll drive uses only the energy required to drive the scroll; it does not waste energy from the main drive. No braking action like on electrical back-drive systems, no energy conversion losses
- The direct precise speed control together with the highest torque capability permit increased through-put capacities



5.7 Reduction or Elimination of „Chatter or Slip-Stick”

Some products, when sedimented in a centrifuge, have a tendency to cause torque peaks, torque oscillations “Chatter or Slip-Stick” (mostly by plasticizing). For example certain Starches, Cellulose derivatives, some crystalline products, P.V.C, Polysaccharides, Co-angulated blood, sulphur flower, or also less frequently caseins etc.. Such oscillations have devastating effects on a rigid drive systems (gear boxes) and lead to a short lifetime.

- The hydrostatic drives superb damping characteristics that can be further increased by changing the hydraulic impedance of the system
- If necessary, with the installation of a suitable hydraulic accumulator system, the damping effect can be enhanced (tuned), this guarantees the life of the drive system.

5.8 Explosion Proof (ATEX) – ATEX Certification-ZONE 1

Applications in various hazardous areas such as oil production and refining will continue to be a challenge to the decanter manufacturer, especially as the centrifuge operation moves into less hospitable zones.

- The very durable and easy to use Viscotherm drive system is particularly suitable in hazardous areas because it contains a minimum of electrical components, which are easily obtainable in ex-proof version; this is in contrast to electric back drives.
- The advantage of explosion proof design (including ATEX certification) will be a key feature to any decanter manufacturing company, contractor or end-user.

Trademark

ROTODIFF® and VISCOTHERM® are registered Trade marks of Viscotherm AG



Products Overview

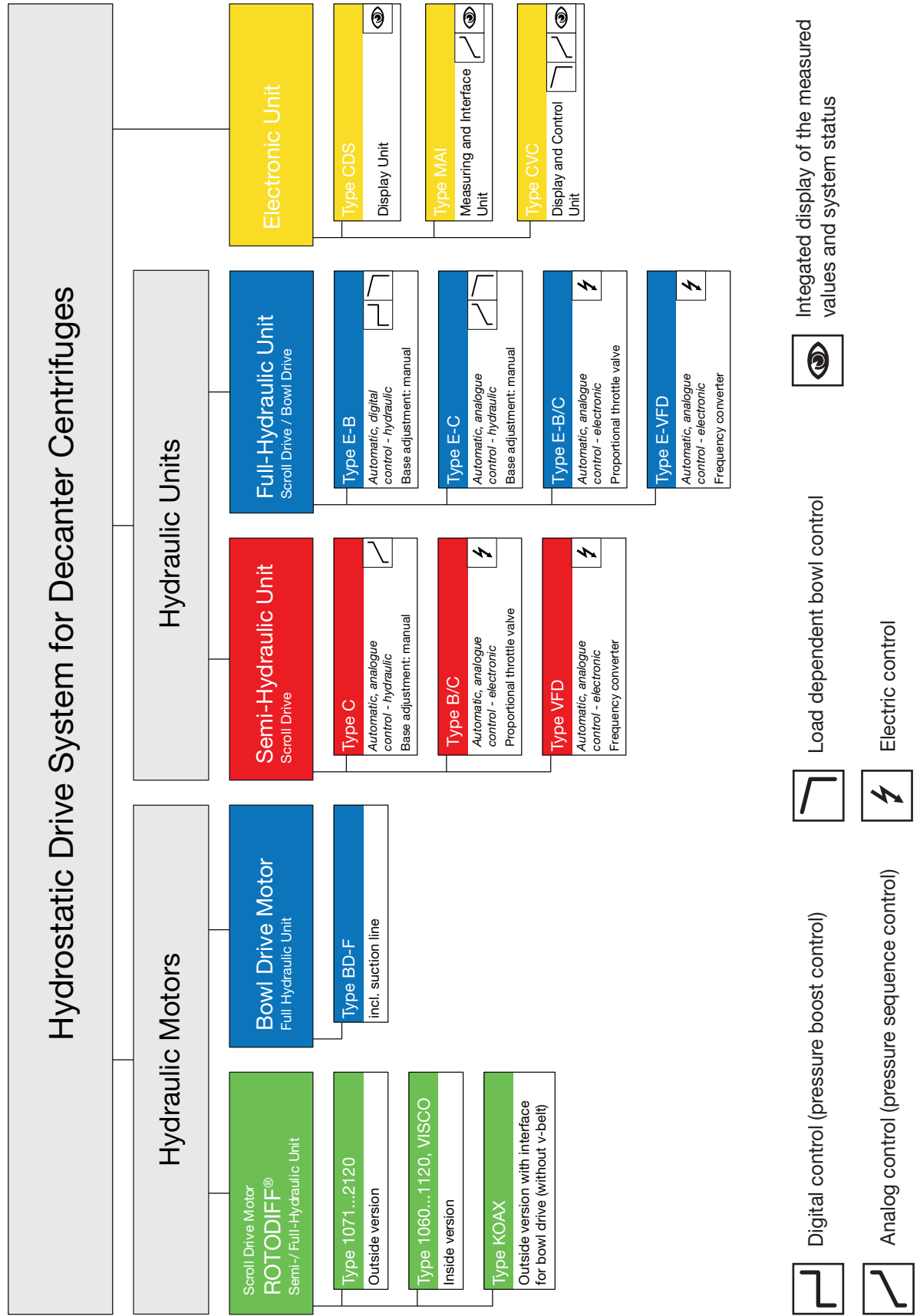



ROTODIFF®

Type Key

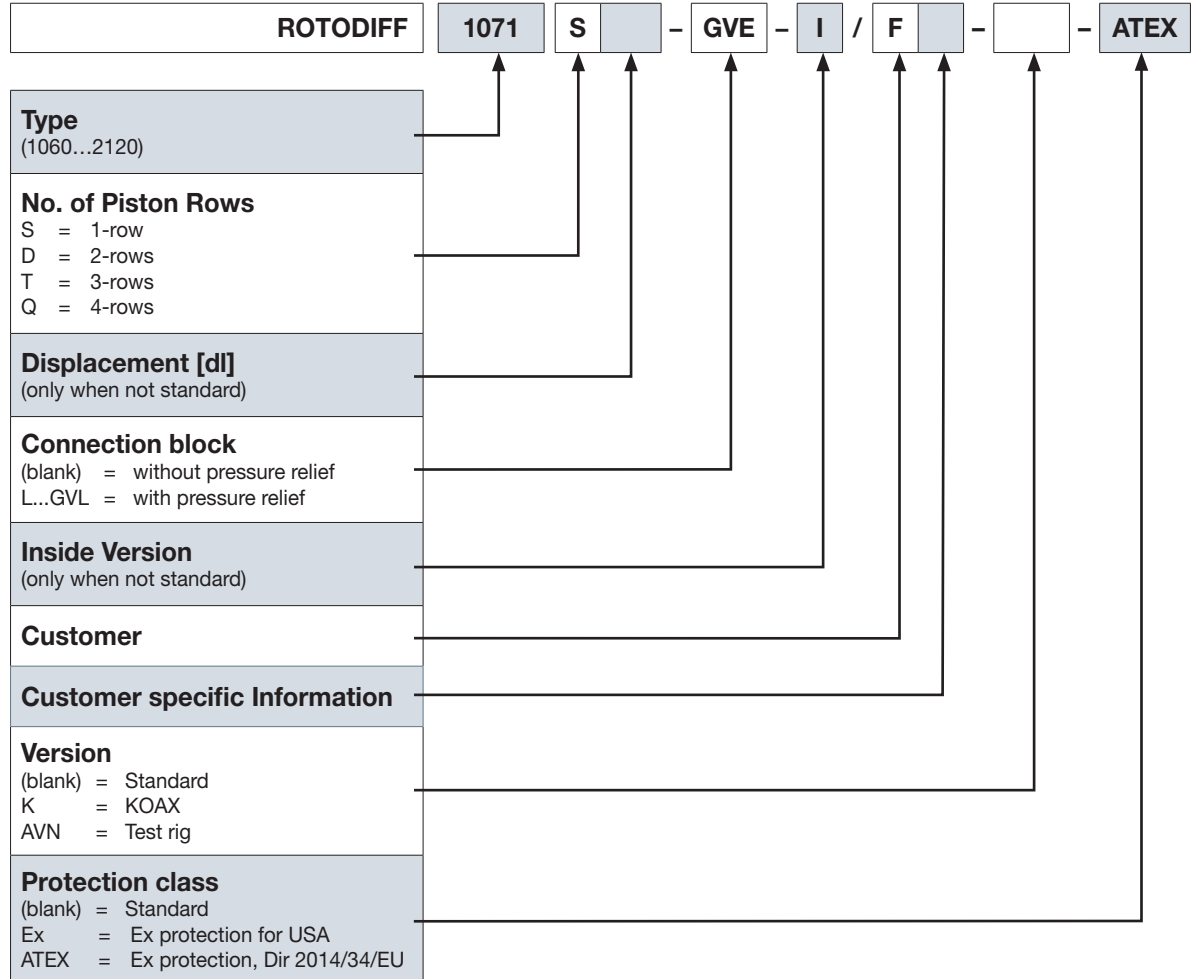



ROTODIFF®

Product survey

Type	Technical Data							
	Max. Pressure (Pressure Relief Valve)	Max. Torque	Max. Continuous Pressure	Max. Continuous Torque	Displacement	Max. Bowl Speed	Max. Differential Speed	Weight
	[bar]	[Nm]	[bar]	[Nm]	[l/rev]	[rpm]	[rpm]	[kg]
1060 S017	300	816	250	680	0.171	6500	133	27
1060 S017-L							193	
1060 S	300	1022	250	851	0.214	6500	105	27
1060 S-L							154	
1060 D	300	2044	250	1703	0.428	6500	53	30
1060 D-L							77	
1071 S06-L	300	2994	250	2495	0.627	4500	75	70
1071 S06-GVE							190	
1071 S06-GVL							199	
1071 S-L	300	4460	250	3716	0.934	4500	60	70
1071 S-GVE							134	
1071 S-GVL							192	
2071 S-L	300	6479	250	5399	1.357	4500	41	75
2071 S-GVE							92	
2071 S-GVL							133	
1071 D15-L	300	7448	250	6207	1.560	4500	35	80
1071 D15-GVE							79	
1071 D15-GVL							114	
1071 D-L	300	8919	250	7433	1.868	4500	30	80
1071 D-GVE							67	
1071 D-GVL							96	
2071 D-L	300	12959	250	10799	2.714	4500	21	85
2071 D-GVE							46	
2071 D-GVL							66	
1080 D32-GVE	300	15002	250	12502	3.142	3500	40	170
1080 D32-GVL							57	
1080 D-GVE	300	16616	250	13846	3.480	3500	36	170
1080 D-GVL							51	
1080HD D-GVL							80	



ROTODIFF®

Product survey

Type	Technical Data							
	Max. Pressure (Pressure Relief Valve)	Max. Torque	Max. Continuous Pressure	Max. Continuous Torque	Displacement	Max. Bowl Speed	Max. Differential Speed	Weight
	[bar]	[Nm]	[bar]	[Nm]	[l/rev]	[rpm]	[rpm]	[kg]
1080 D42-GVE	300	20054	250	16711	4.200	3500	30	170
1080 D42-GVL							43	
2080 D-GVE	300	25425	250	21188	5.325	3500	23	180
2080 D-GVL							34	
2080HD-D-GVL							60	
1120 D66-GVL	300	31513	250	26261	6.600	3000	73	350
1120 D-GVL	300	39630	250	33025	8.300	3000	58	350
1120 D100-GVL	300	47790	250	39825	10.000	3000	48	355
1120 Q-GVL	300	79259	250	66049	16.600	3000	29	500
1120 Q200-GVL	300	95492	250	79578	20.000	3000	30	-

Scope of Delivery

- ROTODIFF complete with hydraulic connections (excl. mounting screws and hydraulic hoses)
- Paint in RAL
- Speed sensors for scroll and bowl speed

Options

- V-belt pulley

All ROTODIFF's are also available as ATEX version.



Pump Unit for Scroll Drive

Type Key

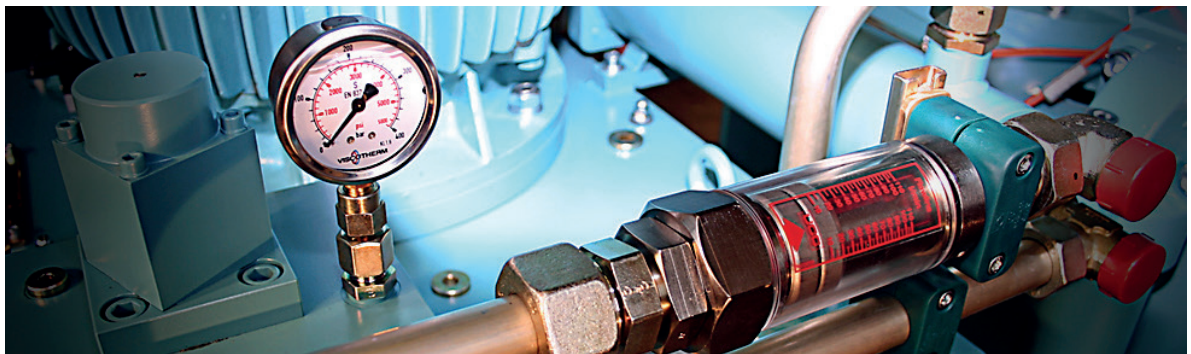
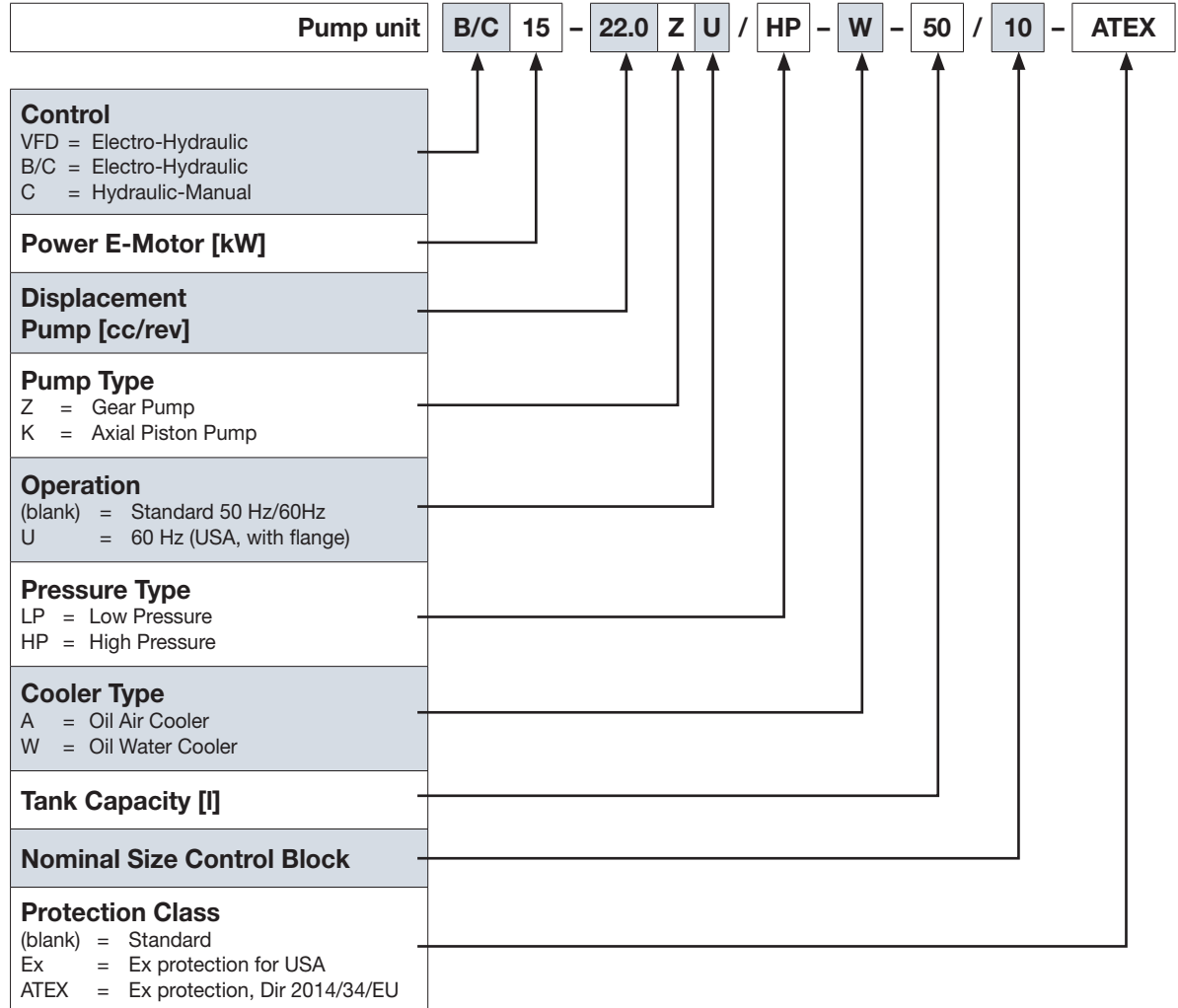



Pump Unit C

Product Survey

Type	Technical Data						
	Power E-Motor [kW]	Max. Pressure Pump (Pressure Valve) [bar]	Max. Flow Pump [cc/rev]	Pressure/Power Limit Point max. Flow at max. Working Pres- sure 250 bar (50 Hz) [l/rev]	Max. Flow at max. possible Pressure (50 Hz) [l/min]/[bar]	Tank Capacity [rpm]	Dimensions (l×w×h) [mm]
C 3-4.1 Z/HP	3	280	4.1	6.0	–	50	705×600×685
C 5.5-7.0 Z/HP	5.5	280	7.0	11.0	–	50	705×600×730
C 7.5-11.5 Z/HP	7.5	280	11.5	15.0	–	50	705×600×770
C 11-16.0 Z/HP	11	280	16.0	22.0	–	50	705×600×850
C 15-22.0 Z/HP	15	280	22.0	31.0	–	50	705×600×895
C 18.5-26.0 Z/HP	18.5	280	26.0	38.0	–	50	705×600×915
C 22-33.0 Z/HP	22	280	33.0	45.0	–	75	705×600×1125
C 22-45.0 K	22	280	45.0	45.0	63.0/178	150	930×825×1125
C 30-45.0 K	30	280	45.0	61.0	63.0/243	150	930×825×1190
C 30-71.0 K	30	280	71.0	61.0	100.0/153	150	930×825×1190
C 37-71.0 K	37	280	71.0	76.0	100.0/189	150	930×825×1240
C 45 -71.0 K	45	280	71.0	92.0	100.0/230	150	930×825×1240
C 55-100.0 K	55	280	100.0	112.0	140.0/200	250	1180×920×1415
C 75-100.0 K	75	280	100.0	153.0	140.0/273	250	1180×920×1530

Scope of Delivery

- Oil tank with cleaning cover
- Gear pump or axial piston pump
- Electric motor IEC IE3, (3×400 V–50 Hz / 3×480 V–60 Hz)
- C control block complete incl. manometer pressure switch and flow meter
- Level and temperature indicator
- Level and temperature switch
- High and low pressure hose for ROTODIFF-connections (2500 mm standard length)
- Paint in RAL

Options

- Oil water cooler standard or seawater resistant
- Oil air cooler incl. temperature regulator
- Therm. water control valve cpl.
- Filter blockage indicator electrical
- Terminal box, wired
- Pressure sensor

All pump units are also available as ATEX version.



Pump Unit B/C

Product Survey

Type	Technical Data						
	Power E-Motor [kW]	Max. Pressure Pump (Pressure Valve) [bar]	Max Flow Pump [cc/rev]	Pressure/Power Limit Point max. Flow at max. Working Pressure 250 bar (50 Hz) [l/rev]	Max. Flow at max. possible Pressure (50 Hz) [l/min]/[bar]	Tank Capacity [rpm]	Dimensions (l×w×h) [mm]
B/C 3-4.1 Z/HP	3	280	4.1	6.0	–	50	705×600×685
B/C 5.5-7.0 Z/HP	5.5	280	7.0	11.0	–	50	705×600×730
B/C 7.5-11.5 Z/HP	7.5	280	11.5	15.0	–	50	705×600×770
B/C 11-16.0 Z/HP	11	280	16.0	22.0	–	50	705×600×850
B/C 15-22.0 Z/HP	15	280	22.0	31.0	–	50	705×600×895
B/C 18.5-26.0 Z/HP	18.5	280	26.0	38.0	–	50	705×600×915
B/C 22-33.0 Z/HP	22	280	33.0	45.0	–	75	705×600×1125
B/C 18.5-28.0 K	18.5	280	28.0	38.0	39.0/242	150	930×825×1125
B/C 22-45.0 K	22	280	45.0	45.0	63.0/178	150	930×825×1190
B/C 30-45.0 K	30	280	45.0	61.0	63.0/243	150	930×825×1190
B/C 30-71.0 K	30	280	71.0	61.0	100.0/153	150	930×825×1240
B/C 37-71.0 K	37	280	71.0	76.0	100.0/189	150	930×825×1240
B/C 45 -71.0 K	45	280	71.0	92.0	100.0/230	150	1180×920×1415
B/C 55-100.0 K	55	280	100.0	112.0	140.0/200	250	1180×920×1530
B/C 75-125.0 K	75	280	125.0	153.0	175.0/219	220	760×1820×1350

Scope of Delivery

- Oil tank with cleaning cover
- Gear pump or axial piston pump
- Electric motor IEC IE3, (3×400 V–50 Hz / 3×480 V–60 Hz)
- B/C control block complete incl. proportional throttle valve and pressure sensor
- Level and temperature indicator
- Level and temperature switch
- High and low pressure hose for ROTODIFF-connections (2500 mm standard length)
- Paint in RAL

Options

- Oil water cooler standard or seawater resistant
- Oil-air cooler incl. temperature regulator
- Therm. water control valve cpl.
- Filter blockage indicator electrical
- Terminal box, wired
- Flow meter
- Electronic unit

All pump units are also available as ATEX version.



Pump Unit VFD

Product survey

Type	Technical Data									
	Power E-Motor	Max. Pressure Pump (Pressure Valve) ¹⁾	Max. Flow Pump	Working speed range pump	Frequency range	Min. Flow at max. Working Pressure (250 bar)	Max. Flow at max. possible Pressure	Pressure/Power Limit Point max. Flow at max. Working Pressure 250 bar	Tank Capacity	Dimensions (xwxh)
	[kW]	[bar]	[ccm/U]	[rpm]	[Hz]	[l/min]	[l/min]/[bar]	[l/min]	[l]	[mm]
VFD 3-2.1 Z/HP	3	280	2.1	300-4300	10-152	0.6	8.6 / 179	6.2	50	690x655x675
VFD 5.5-4.5 Z/HP	5.5	280	4.5	300-3600	10-123	1.3	15.3 / 184	11.3	50	690x655x730
VFD 7.5-6.4 Z/HP	7.5	280	6.4	300-3600	10-123	1.8	21.8 / 176	15.4	50	690x660x815
VFD 11-11.5 Z/HP	11	280	11.5	300-3600	10-123	3.2	39.1 / 144	22.6	50	700x650x880
VFD 15-14.1 Z/HP	15	275	14.1	300-3600	10-123	3.9	48.1 / 160	30.8	50	690x655x895
VFD 18.5-16.0 Z/HP	18.5	275	16.0	300-3600	10-122	4.5	54.4 / 175	38.0	50	700x690x915
VFD 22-17.9 Z/HP	22	275	17.9	300-3600	10-122	5.0	60.6 / 186	45.2	75	700x690x955
VFD 30-33.0 Z/HP	30	280	33.0	300-3000	10-102	9.2	93.6 / 164	61.6	100	800x855x1070
VFD 37-39.0 Z/HP	37	275	39.0	300-3000	10-102	10.9	110.7 / 172	76.0	100	800x855x1120
VFD 45-44.0 Z/HP	45	265	44.0	300-2800	10-95	12.3	117.1 / 197	92.4	100	860x830x1125
VFD 55-64.1 Z/HP	55	280	64.1	400-2600	10-88	18.3	161.5 / 180	114.1	250	955x920x1455
VFD 75-80.7 Z/HP	75	280	80.7	400-2400	10-81	23.1	189.0 / 208	155.6	250	1045x920x1600
VFD 90-101.3 Z/HP	90	270	101.3	400-2400	10-81	28.7	235.0 / 200	187.7	300	1245x970x1670
VFD 110-125.8 Z/HP	110	280	125.8	400-2200	10-74	36.3	268.6 / 215	228.2	350	2055x1580x1145
VFD 132-160.8 Z/HP	132	280	160.8	400-2200	10-74	46.4	343.2 / 202	273.9	500	2055x1580x1350
VFD 160-202.7 Z/HP	160	270	202.7	400-2200	10-74	58.3	431.7 / 194	332.0	500	2055x1580x1350

Scope of Delivery

- Oil tank with cleaning cover
- Gear pump
- Electric motor IEC IE3 (3x400 V–50 Hz)
- VFD control block complete incl. pressure sensor
- Level and temperature indicator
- Level and temperature switch
- High and low pressure hose for ROTODIFF-connection (2500 mm standard length)
- Paint in RAL

Options

- Oil water cooler standard or seawater resistant
- Oil-air cooler incl. temperature regulator
- Frequency converter
- External fan unit for electric motor
- Therm. water control valve cpl.
- Filter blockage indicator electrical
- Terminal box, wired
- Flow meter
- Electronic unit

All pump units are also available as ATEX version.



Full Hydraulic Unit for Scroll and Bowl Drive Type Key

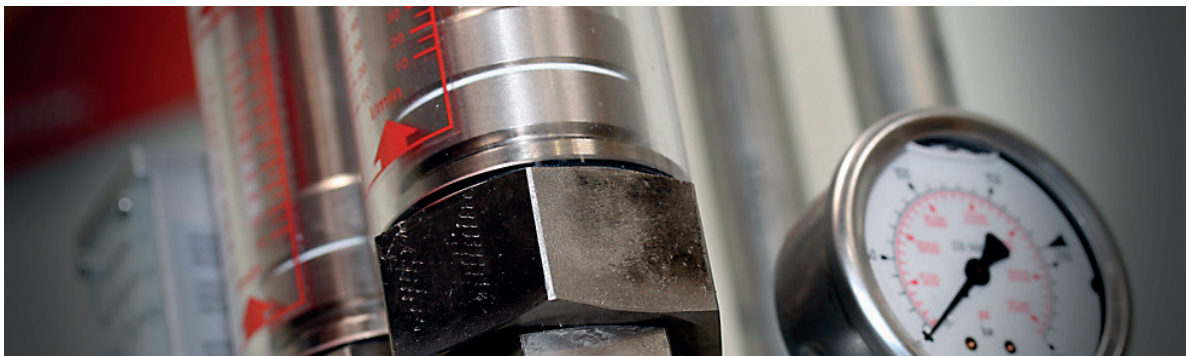
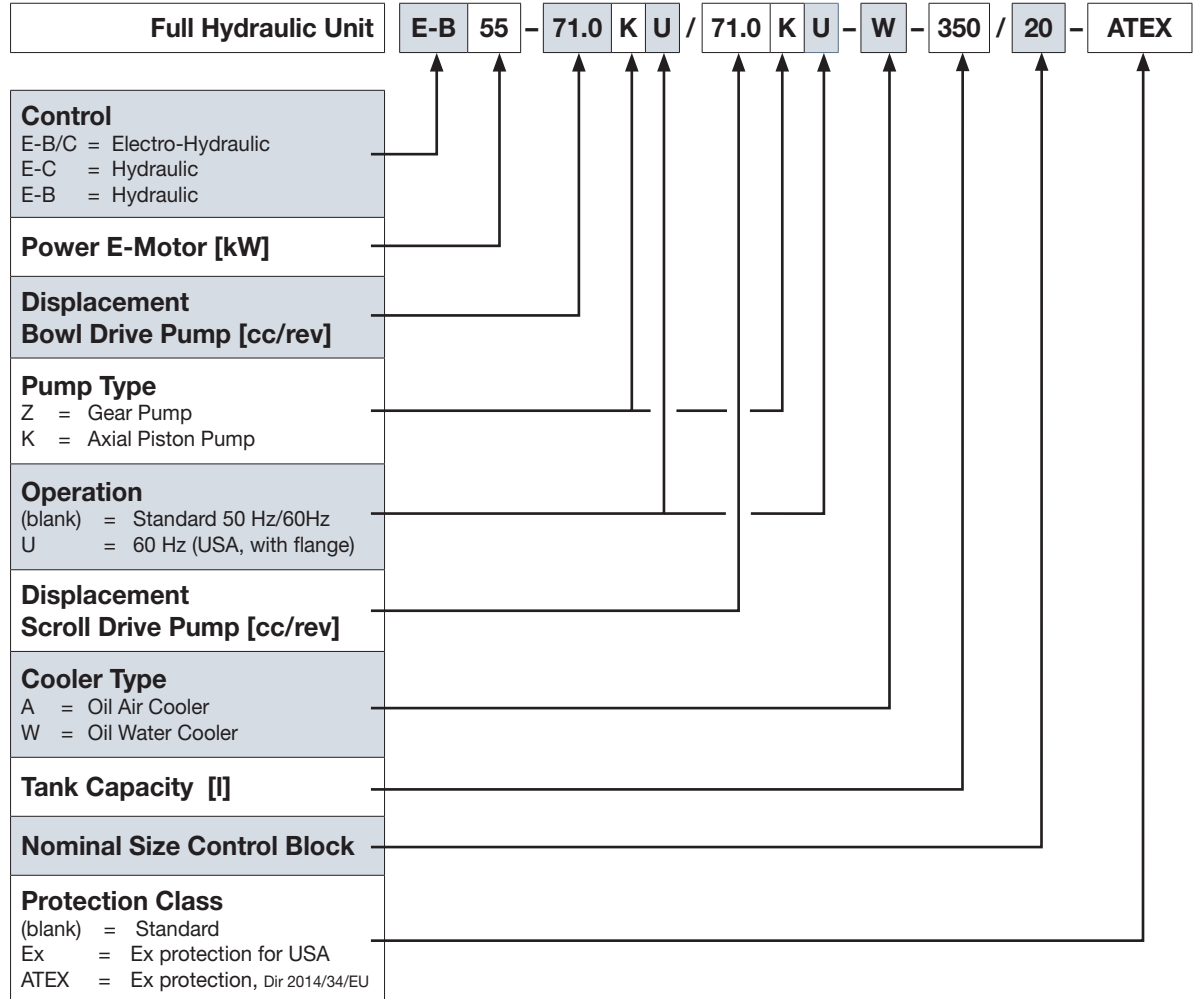



Full Hydraulic Units E-B/C, E-C and E-B

Product Survey

Type	Technical Data				
	Power E-Motor [kW]	Max. Pressure Pumps (Pressure Relief Valves) [bar]	Max Flow Pumps [cc/rev]	Tank Capacity [l]	Dimensions (l×w×h) [mm]
E-X 30-45.0K/45.0K	30	280	45.0/45.0	350	1235×960×1490
E-X 37-45.0K/45.0K	37	280	45.0/45.0	350	1235×960×1575
E-X 45-45.0K/45.0K	45	280	45.0/45.0	350	1235×960×1575
E-X 45-71.0K/45.0K	45	280	71.0/45.0	350	1235×960×1575
E-X 55-71.0K/45.0K	55	280	71.0/45.0	350	1235×960×1620
E-X 55-71.0K/71.0K	55	280	71.0/71.0	350	1235×960×1620
E-X 75-71.0K/71.0K	75	280	71.0/71.0	350	1235×960×1700
E-X 75-100.0K/45.0K	75	280	100.0/45.0	350	1235×985×1700
E-X 90-100.0K/71.0K	90	280	100.0/71.0	450	1235×985×2075
E-X 110-140.0K/100.0K	110	280	140.0/100.0	450	1235×985×2320

Scope of Delivery

- Oil tank with cleaning cover
- Axial piston pump / gear pump or axial piston pump / axial piston pump
- Electric motor IEC IE3 (3×400 V–50 Hz / 3×480 V–60 Hz)
- Control block complete *
- Return line filter incl., filterblockage indicator optical
- Level and temperature indicator
- Level and temperature switch
- High and low pressure hoses for ROTODIFF-connections (2500 mm standard length)
- Paint in RAL

* **E-B/C control block** complete with pressure sensors and proportional throttle valves for ROTODIFF and bowl circuits, high pressure filter incl. filter blockage indicator optical

EC or EB control block complete with manometer pressure switch, manometer, high pressure filter incl. filter blockage indicator optical, flow meters for ROTODIFF and bowl circuits

Options

- Oil water cooler standard or seawater resistant
- Oil-air cooler incl. temperature regulator
- Therm. water control valve cpl.
- Filter blockage indicator electrical
- Terminal box, wired
- Electronic unit

All full hydraulic units are also available as ATEX version.



Electronic Units

Product Survey

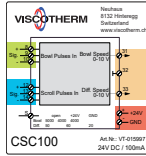

CSC 100
Electronic Measuring Unit



CDS III
Electronic Display Unit



MAI
Electronic Measuring and Interface Unit

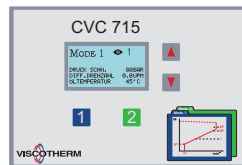

CVC 710/715
Electronic Measuring and Display Unit

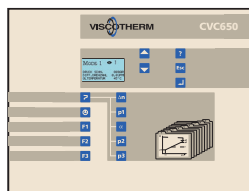

CVC 650
Electronic Control and Display Unit



Electronic Units

Product Survey

Type	Technical Data										
	Display of the measured values	Profibus interface	Etherwert / IP	Analogue set point	Analogue outputs	2 adjustable limit contacts	Integrated proportional amplifier control	Integrated amplifier for pumps with position monitoring	Programmable tools for process control	Local operating	Explosion proof (ATEX)
Measurement Unit											
CSC 100	-	-	-	-	x	-	-	-	-	-	-
Display Unit											
CDS III	x	-	-	-	x	x	-	-	-	x	-
I/O-Unit											
MAI 311	-	-	-	x	x	x	x	-	-	x	-
MAI 312	-	x	-	-	x	x	x	-	1	x	-
MAI 314	-	-	x	-	x	x	x	-	1	x	-
Control Unit											
CVC 650	x	•	•	-	•	x	•	•	9	x	-
CVC 715	x	-	-	-	x	x	x	-	2	x	-

Application	Type							
	CSC 100	CDS III	MAI 311	MAI 312	MAI 314	CVC 650	CVC 715	
Pump Unit B	x	x	-	-	-	-	-	
Pump Unit C	x	x	-	-	-	-	-	
Pump Unit B/C	x	-	x	x	x	x	x	
Pump Unit VFD	x	-	x	x	x	x	x	
Full Hydraulic Unit E-B	x	x	-	-	-	-	-	
Full Hydraulic Unit E-C	x	x	-	-	-	-	-	
Full Hydraulic Unit E-B/C	-	-	-	-	-	x	-	

- x Function always available
- Alternate function (dependent on configuration)